

COURSE SELECTION



GRADE 10

DUE DATE
February 28

**Ontario Secondary
School Diploma**

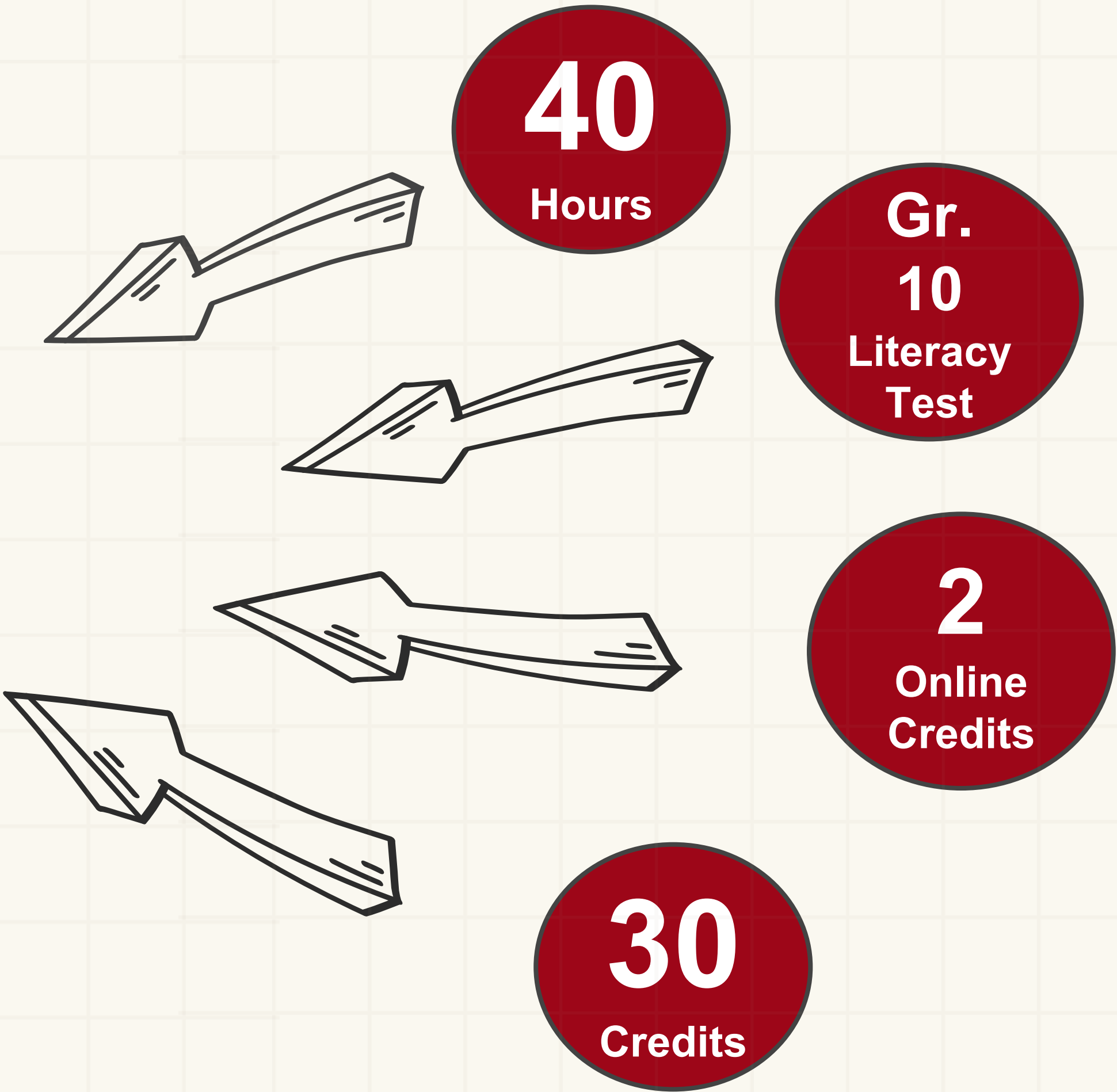

17 Compulsory

- 4 English
- 3 Math (1 gr. 11 or 12)
- 1 History (gr. 10)
- 1 Geography (gr. 9)
- 1 Arts
- 1 Physed/Health
- 1 French
- 1 Tech (Gr. 9 or 10)
- 0.5 Careers
- 0.5 Civics
- 1 STEM related course
 - Business
 - Computer Studies
 - Coop
 - Math (gr. 12)
 - Science (gr. 11/12)
 - 2nd Tech

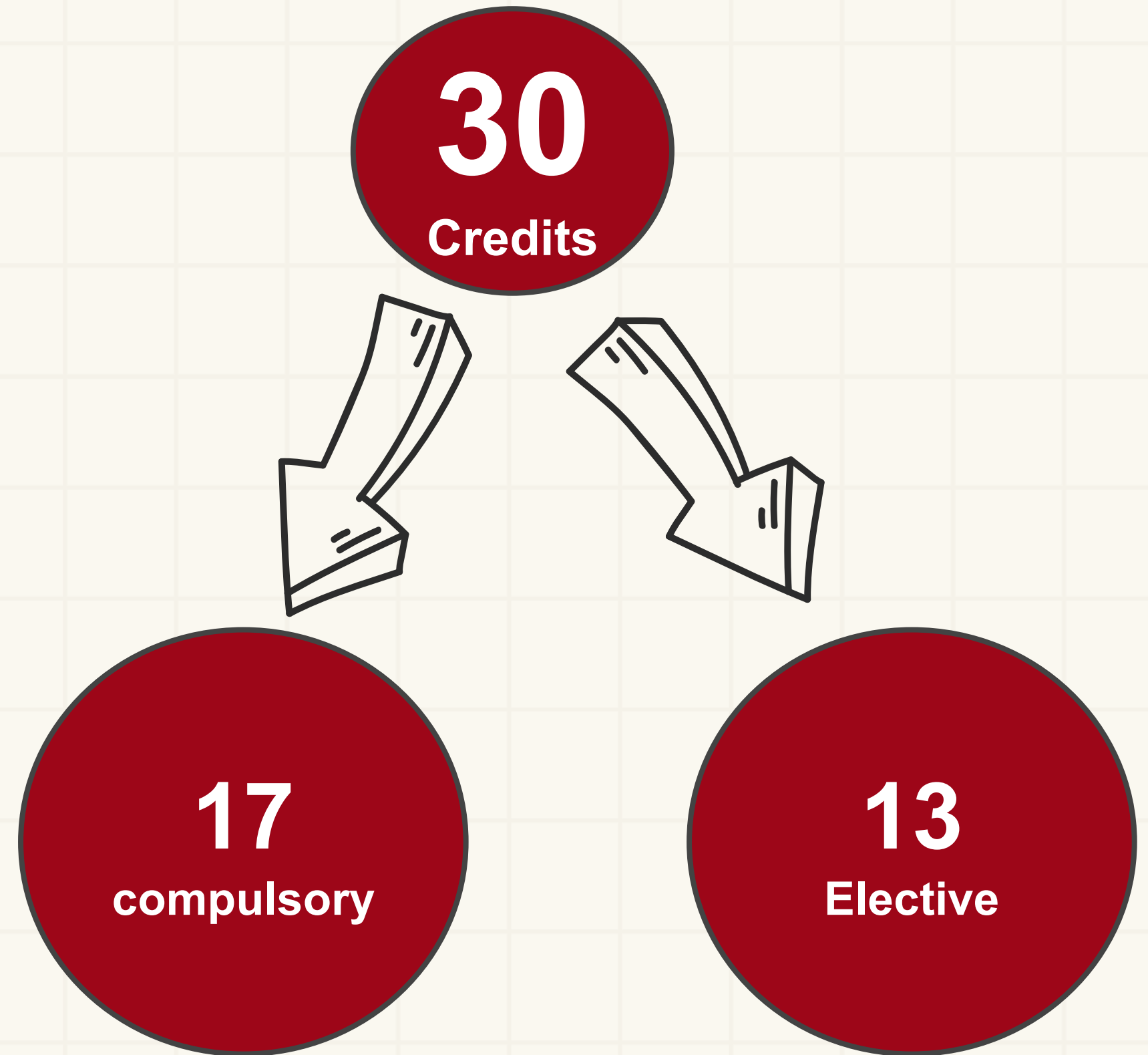

17 Compulsory

- 4 English
- 3 Math (1 gr. 11 or 12)
- 1 History (gr. 10)
- 1 Geography (gr. 9)
- 1 Arts
- 1 Physed/Health
- 1 French
- 1 Tech (Gr. 9 or 10)
- 0.5 Careers
- 0.5 Civics
- 1 STEM related course
 - Business
 - Computer Studies
 - Coop
 - Math (gr. 12)
 - Science (gr. 11/12)
 - 2nd Tech

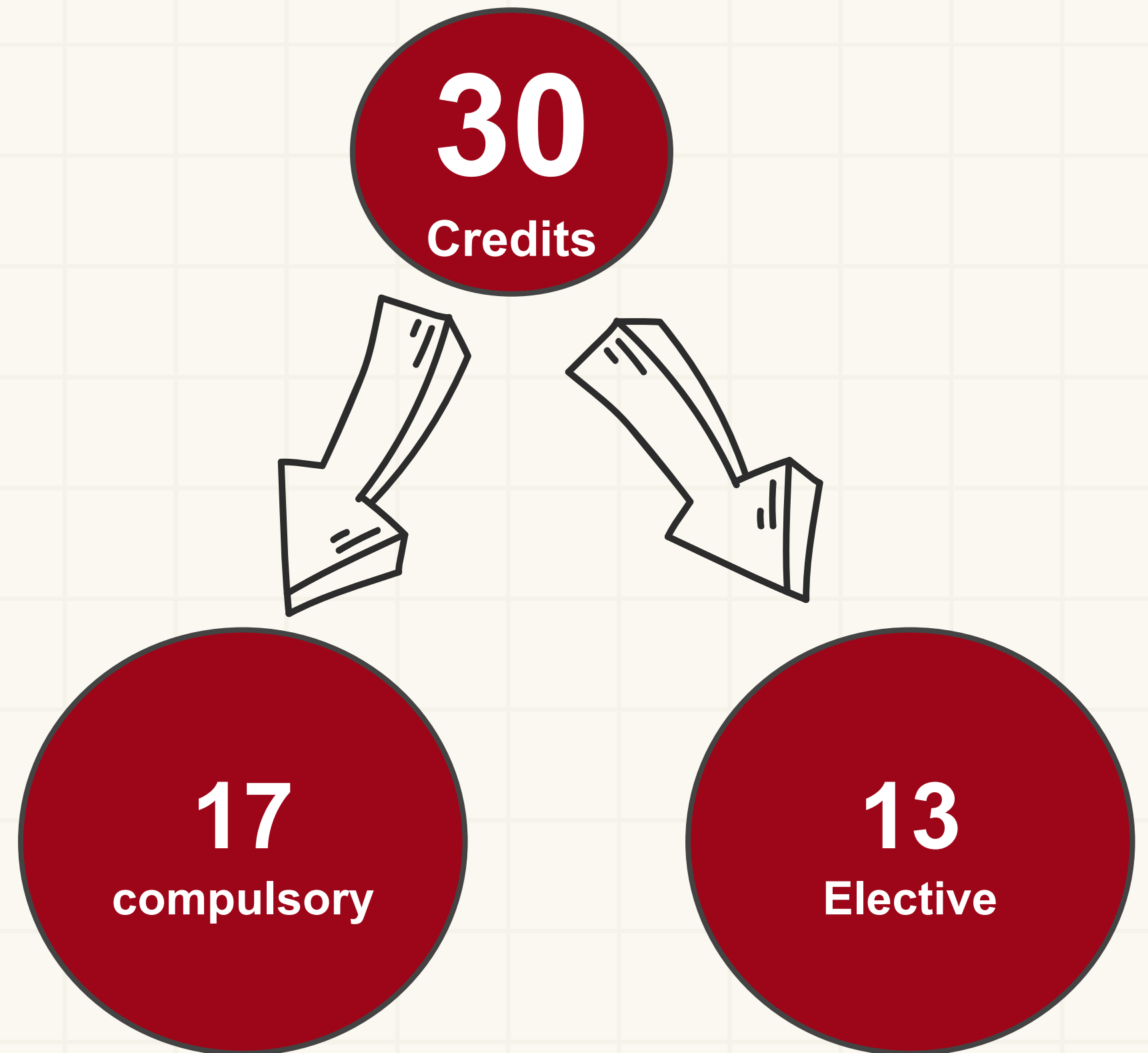

30
Credits

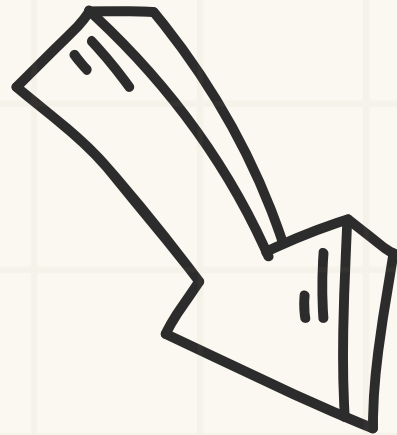

17
compulsory

13
Elective

You must take:

- English
- Religion
- Math

Plus 5 Electives

PATHWAYS

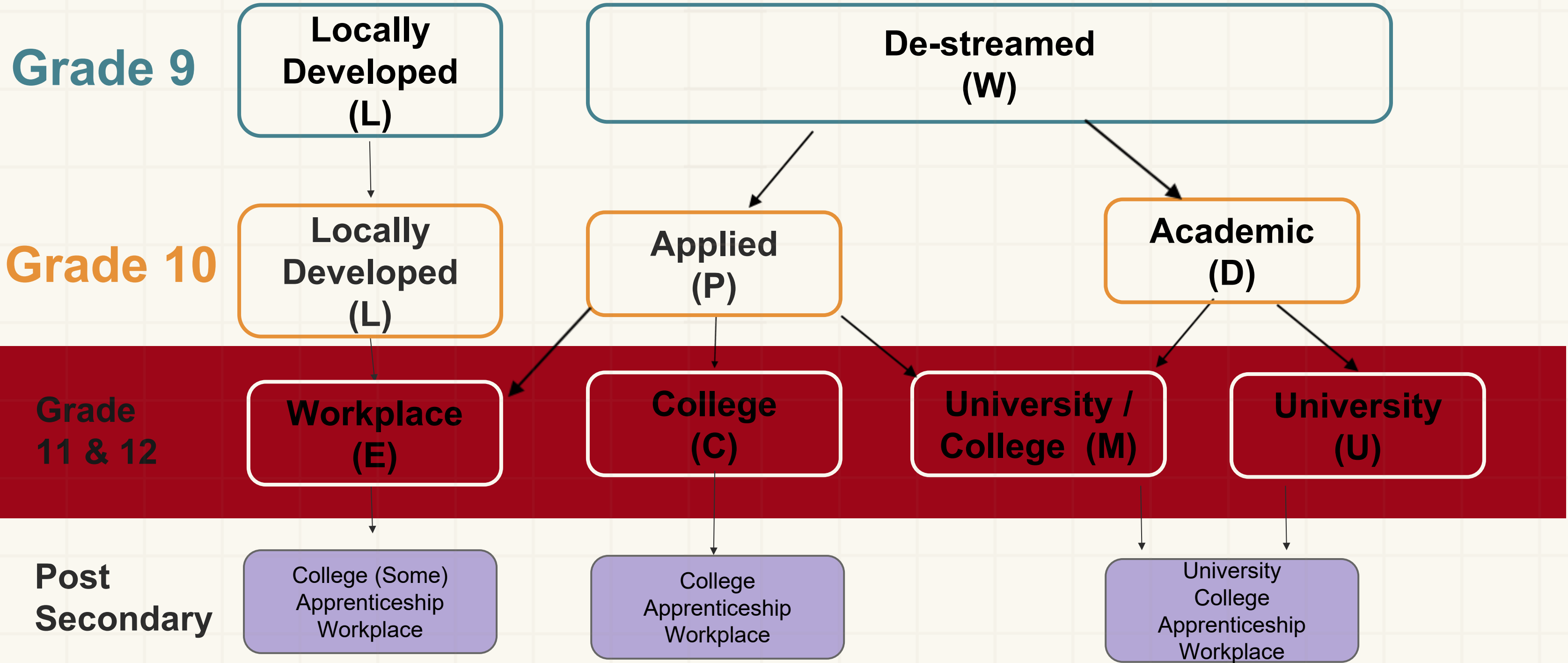

PATHWAYS

What is a Pathway?

Your Pathway is the direction your learning is taking you after high school

APPRENTICESHIP
COLLEGE
COMMUNITY
WORKPLACE
UNIVERSITY

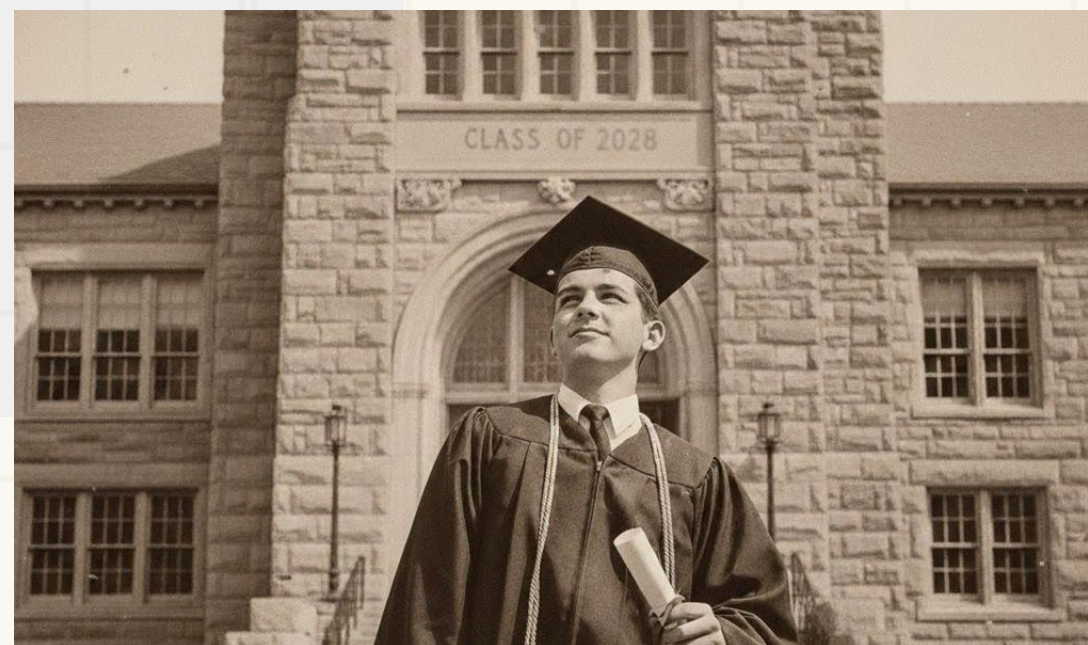



**Waterloo Catholic
District School Board**
**Pathways through
Mathematics**

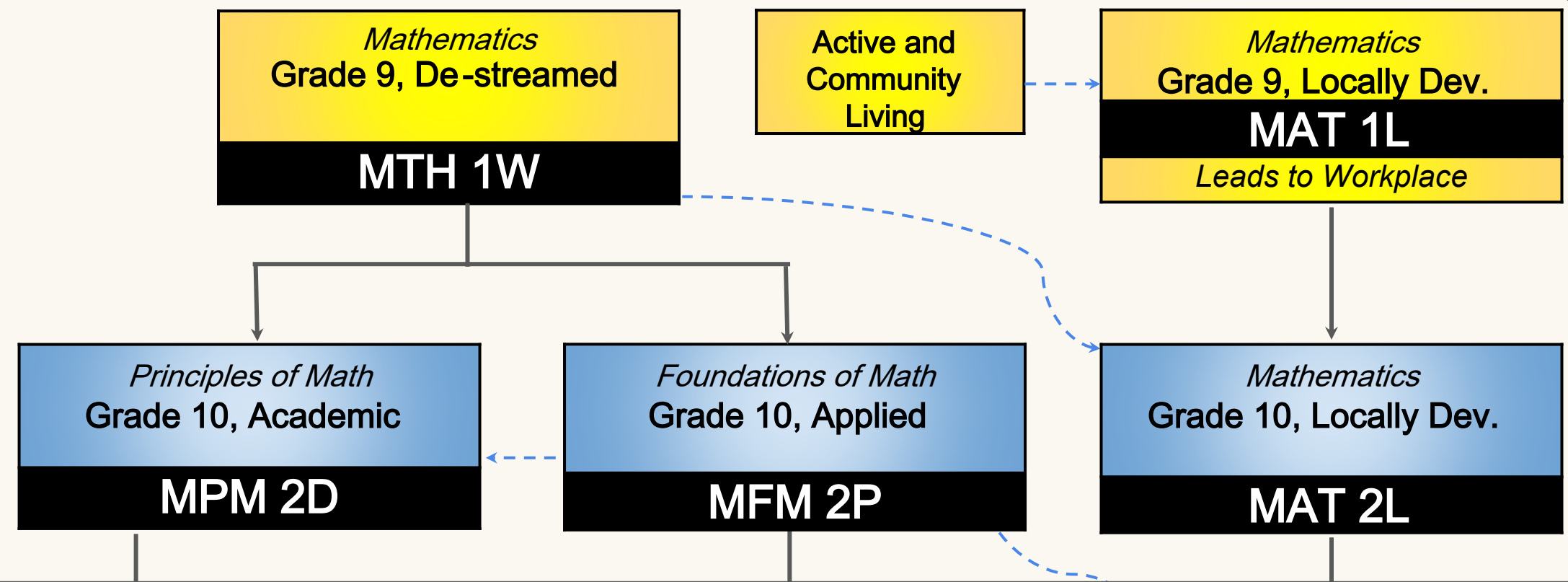

MATH Pathway



**Waterloo Catholic
District School Board
Pathways through
Mathematics**

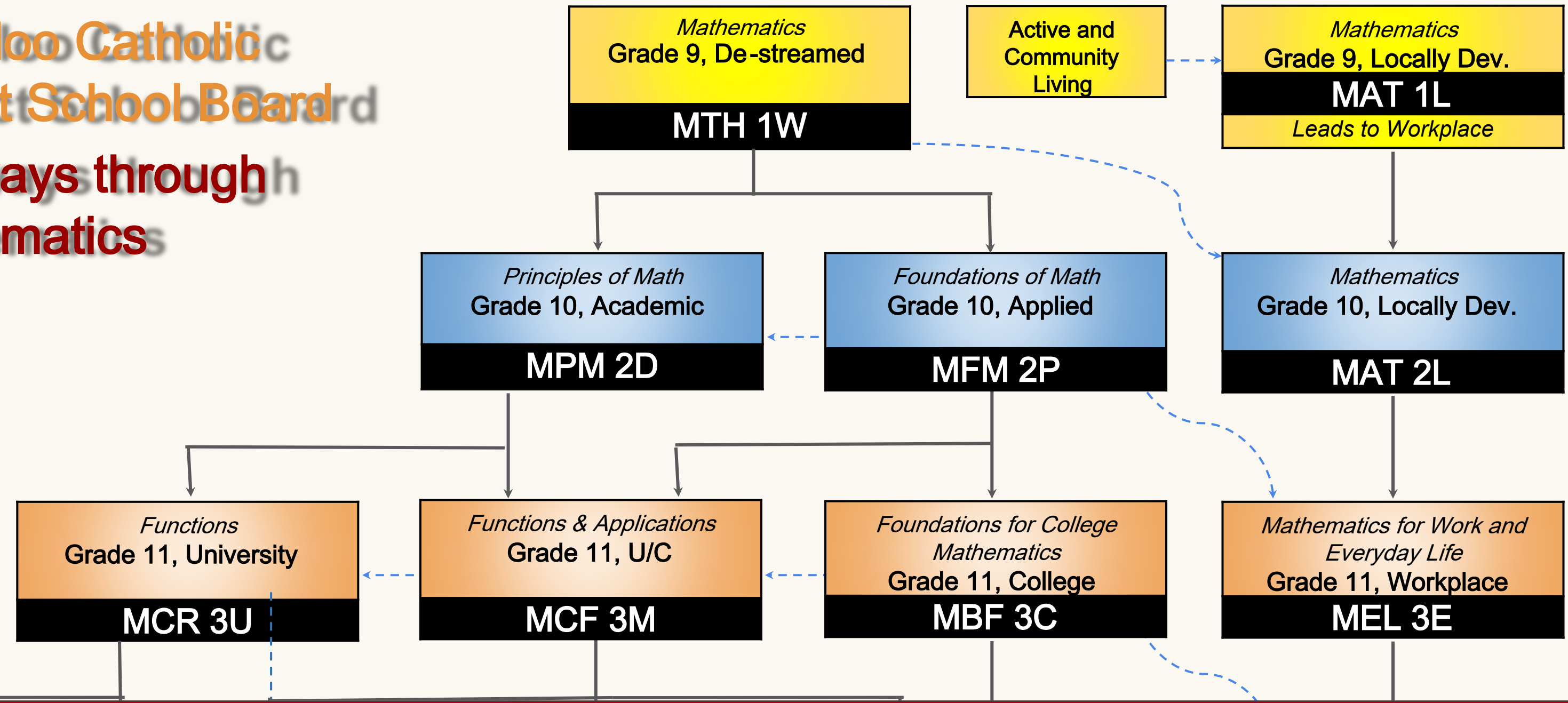

MATH Pathway



Waterloo Catholic District School Board

Pathways through Mathematics

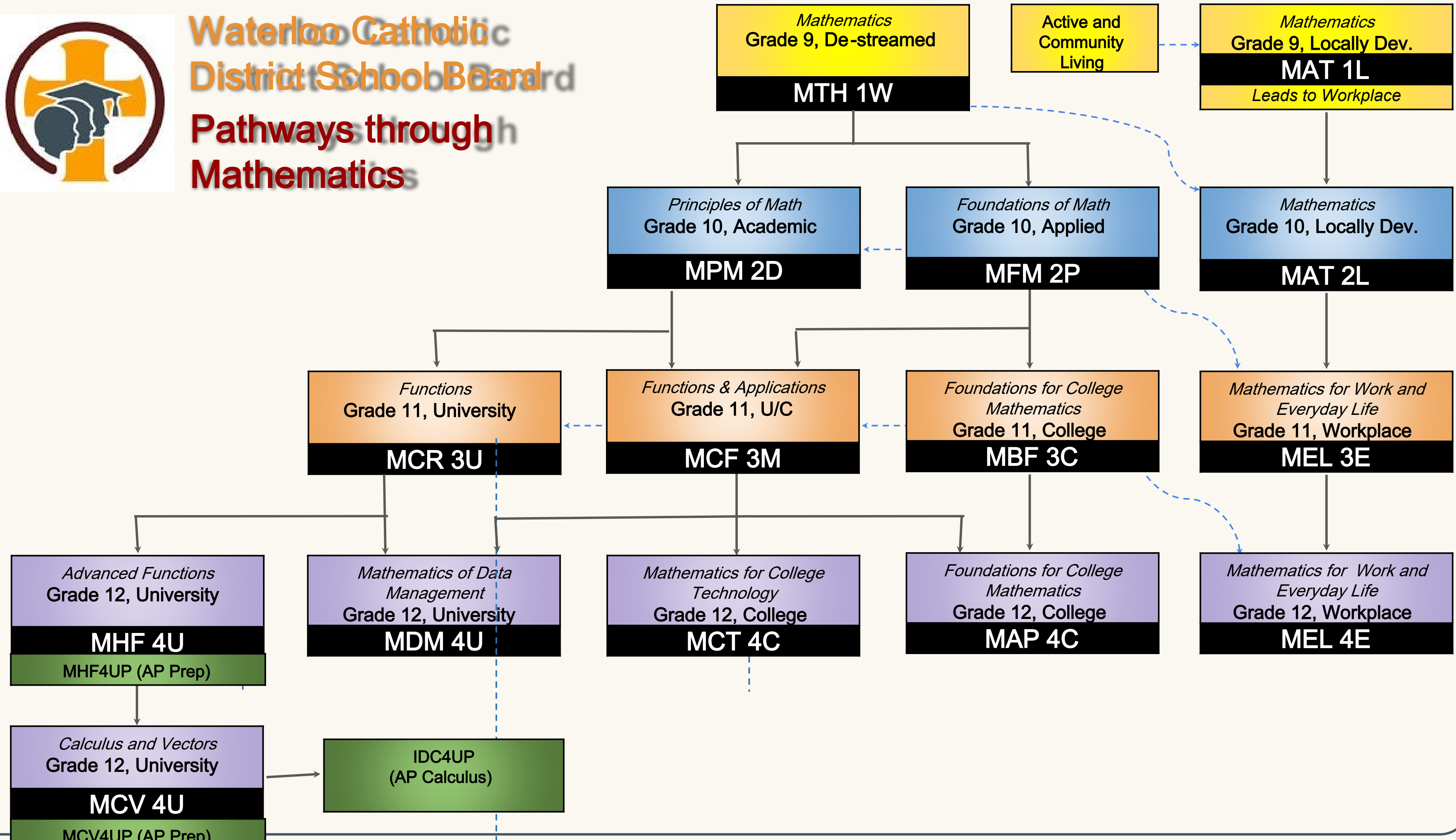



**Waterloo Catholic
District School Board**
**Pathways through
English**

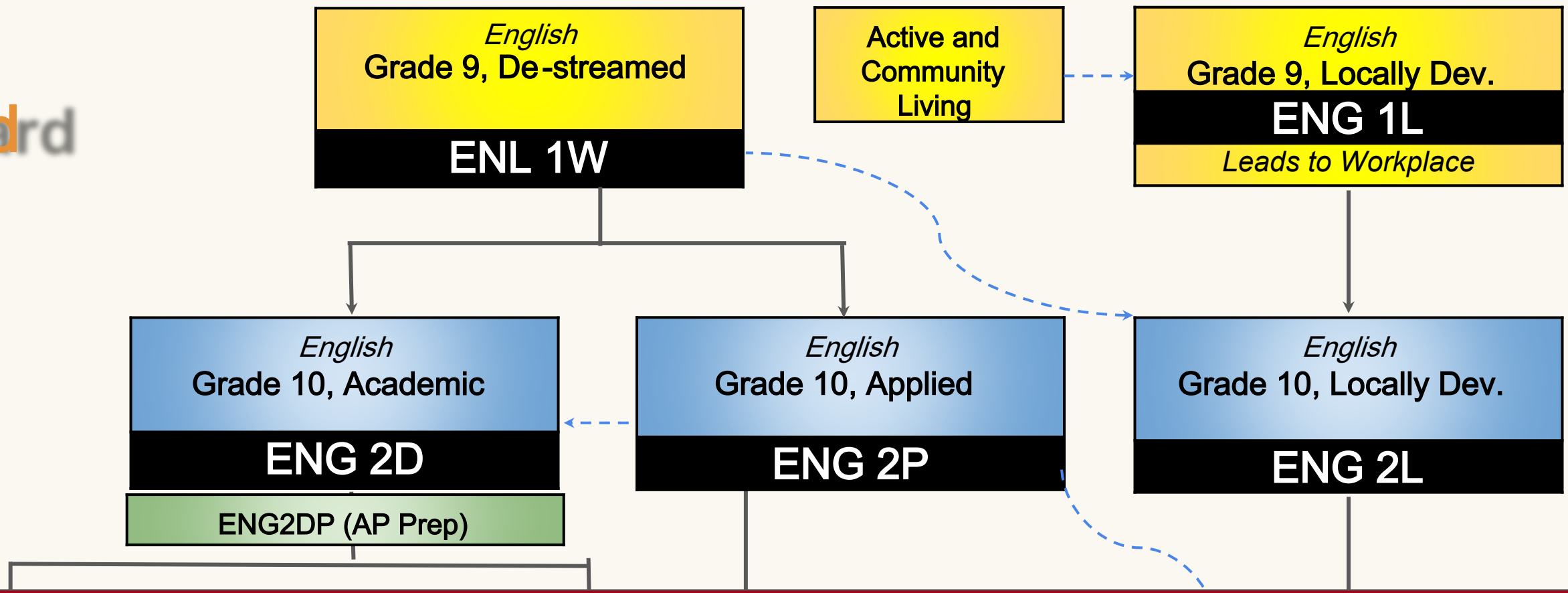

ENGLISH Pathway



**Waterloo Catholic
District School Board**
**Pathways through
English**

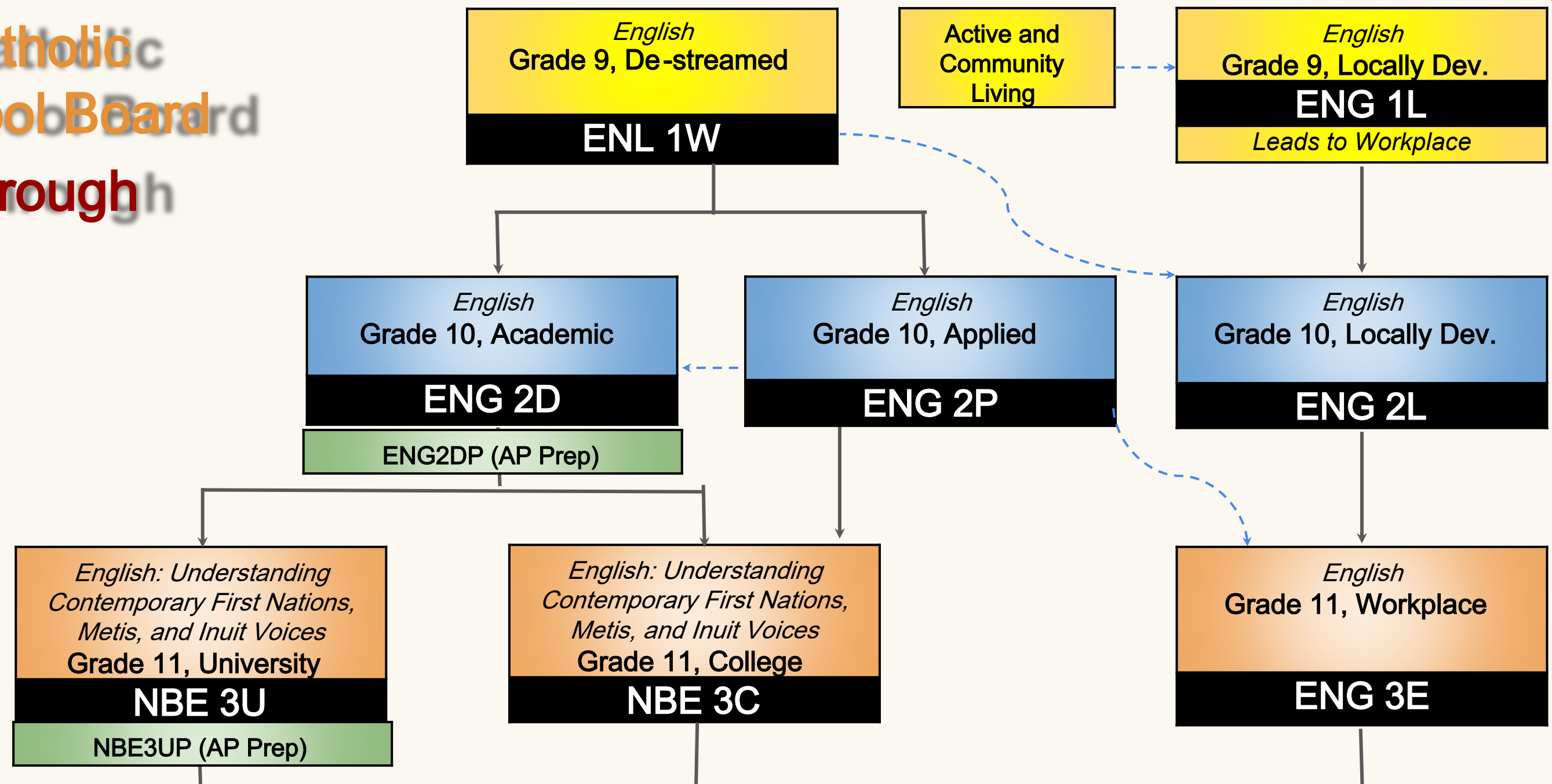

ENGLISH Pathway



Waterloo Catholic District School Board Pathways through English

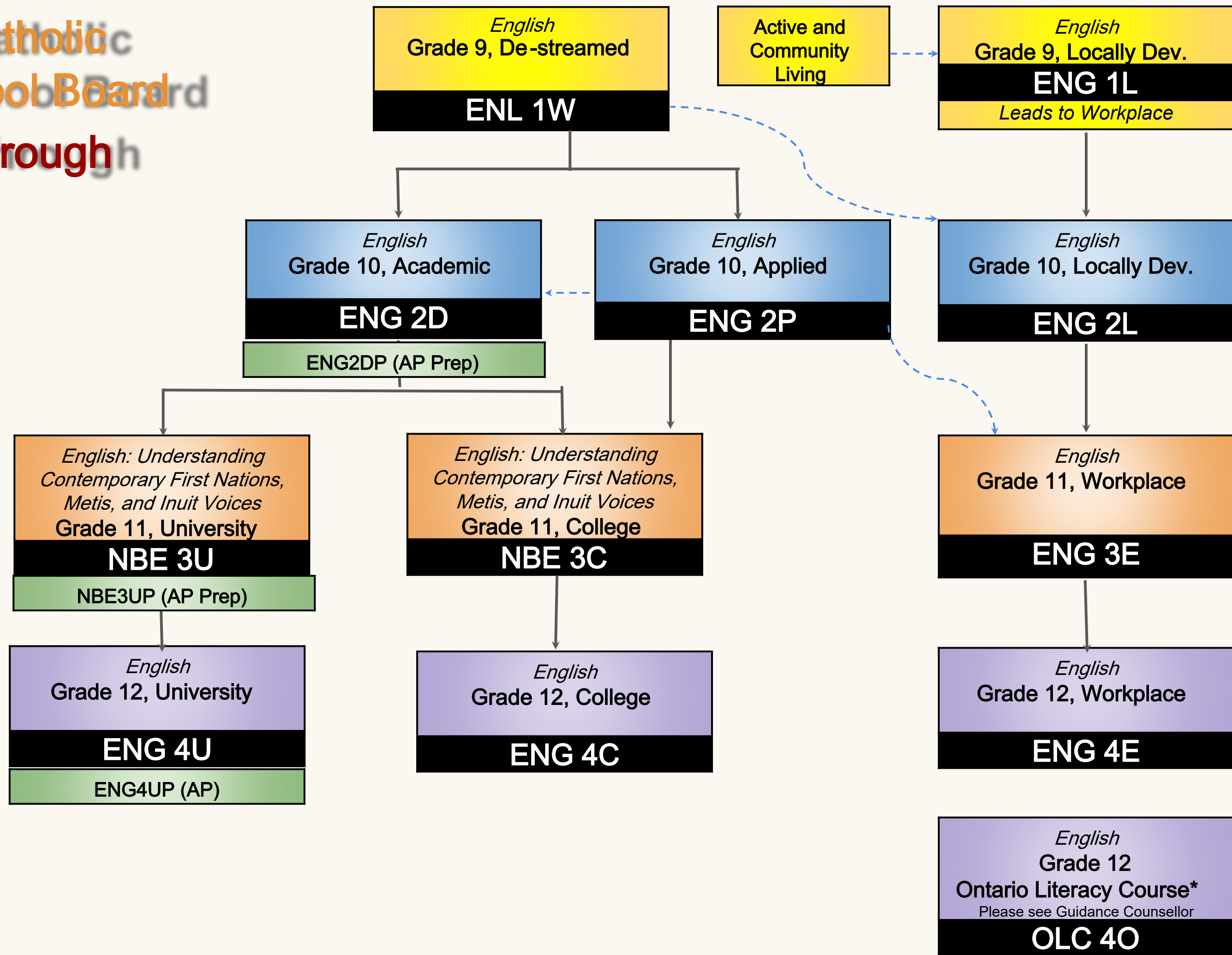



**Waterloo Catholic
District School Board**
**Pathways through
Science**

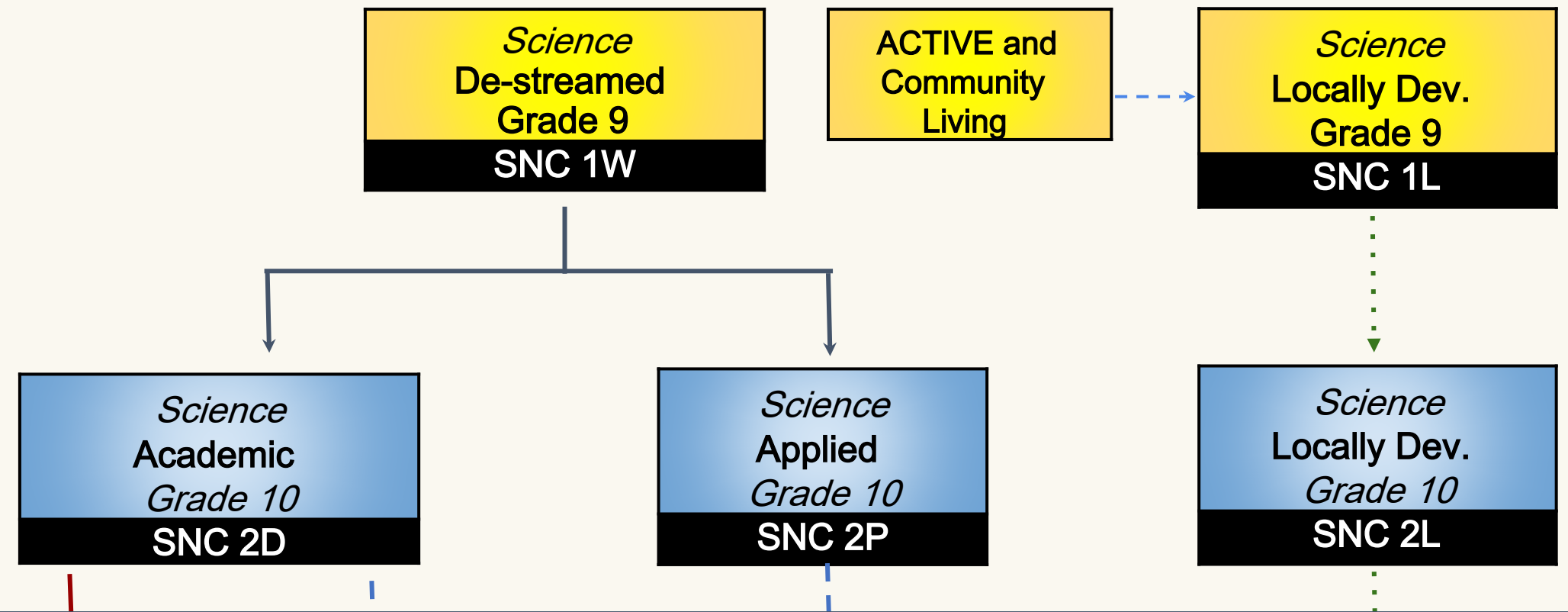

SCIENCE Pathway



**Waterloo Catholic
District School Board**
**Pathways through
Science**

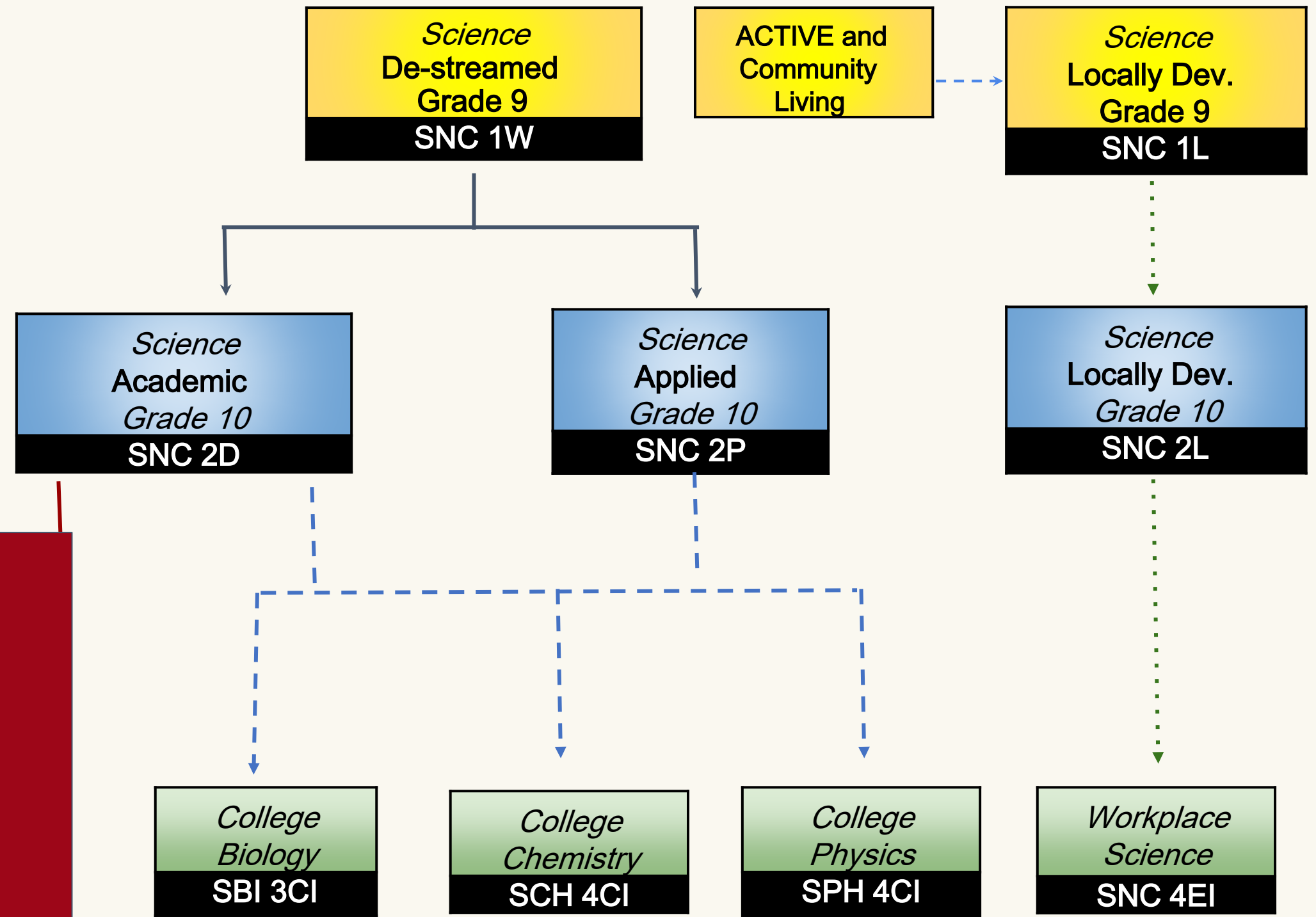

SCIENCE Pathway

Legend

- University Pathway Options ———
- College Pathway Options - - - - -
- Workplace Pathway Options ·····



Waterloo Catholic District School Board Pathways through Science

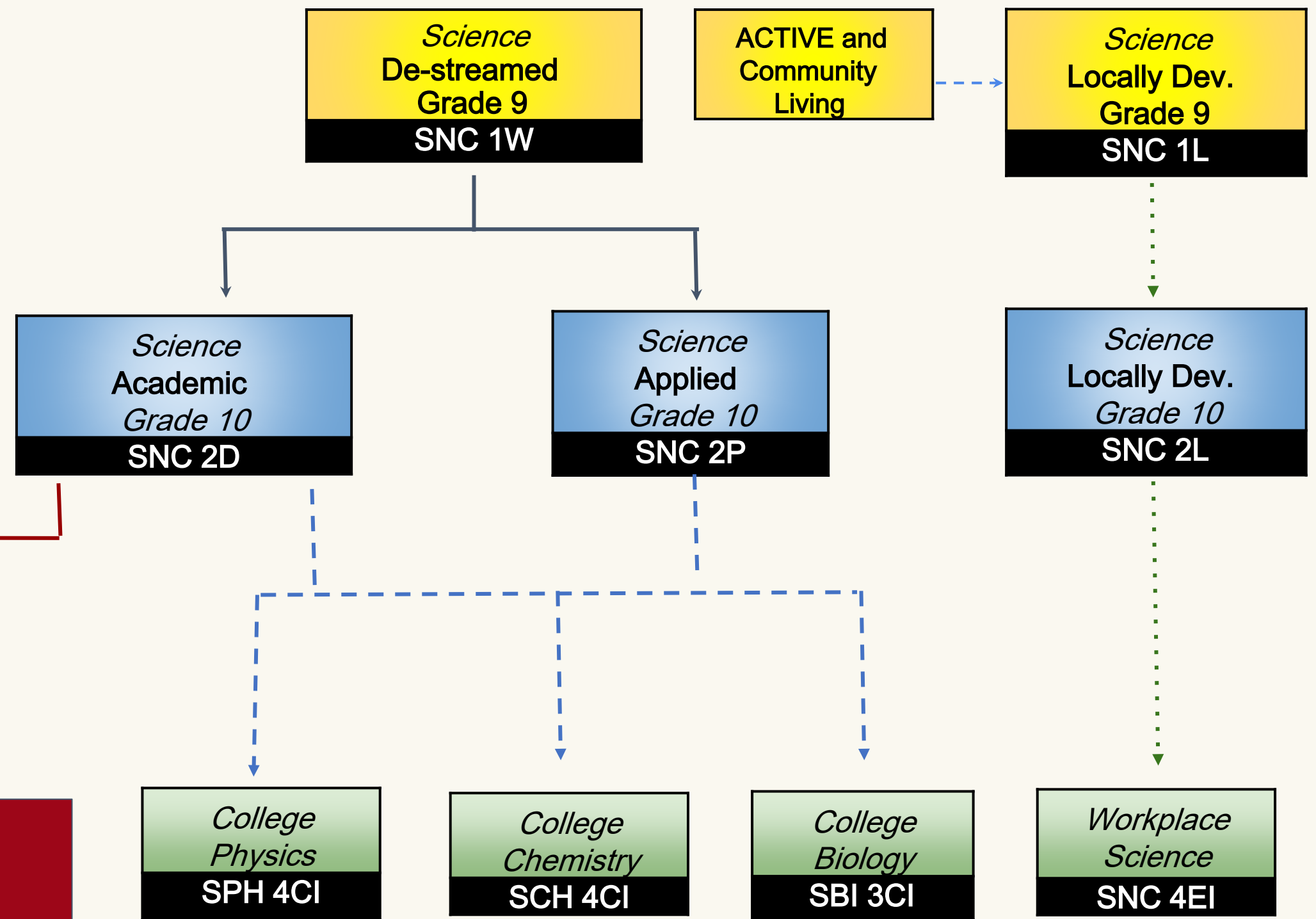

SCIENCE Pathway

Legend

- University Pathway Options ———
- College Pathway Options - - - - -
- Workplace Pathway Options ·····



Waterloo Catholic District School Board

Pathways through Science

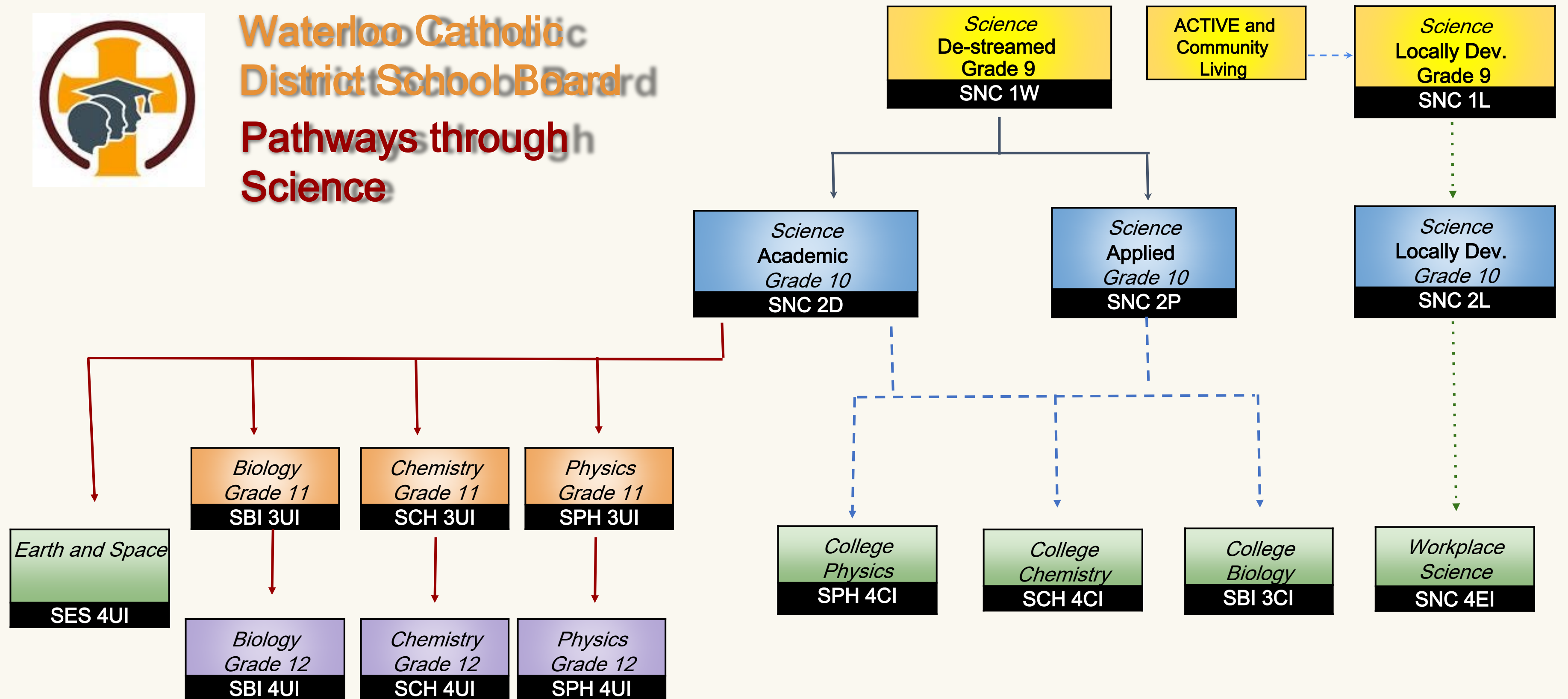

Legend

- University Pathway Options ——— (solid red line)
- College Pathway Options - - - - (dashed blue line)
- Workplace Pathway Options (dotted green line)

PATHWAYS

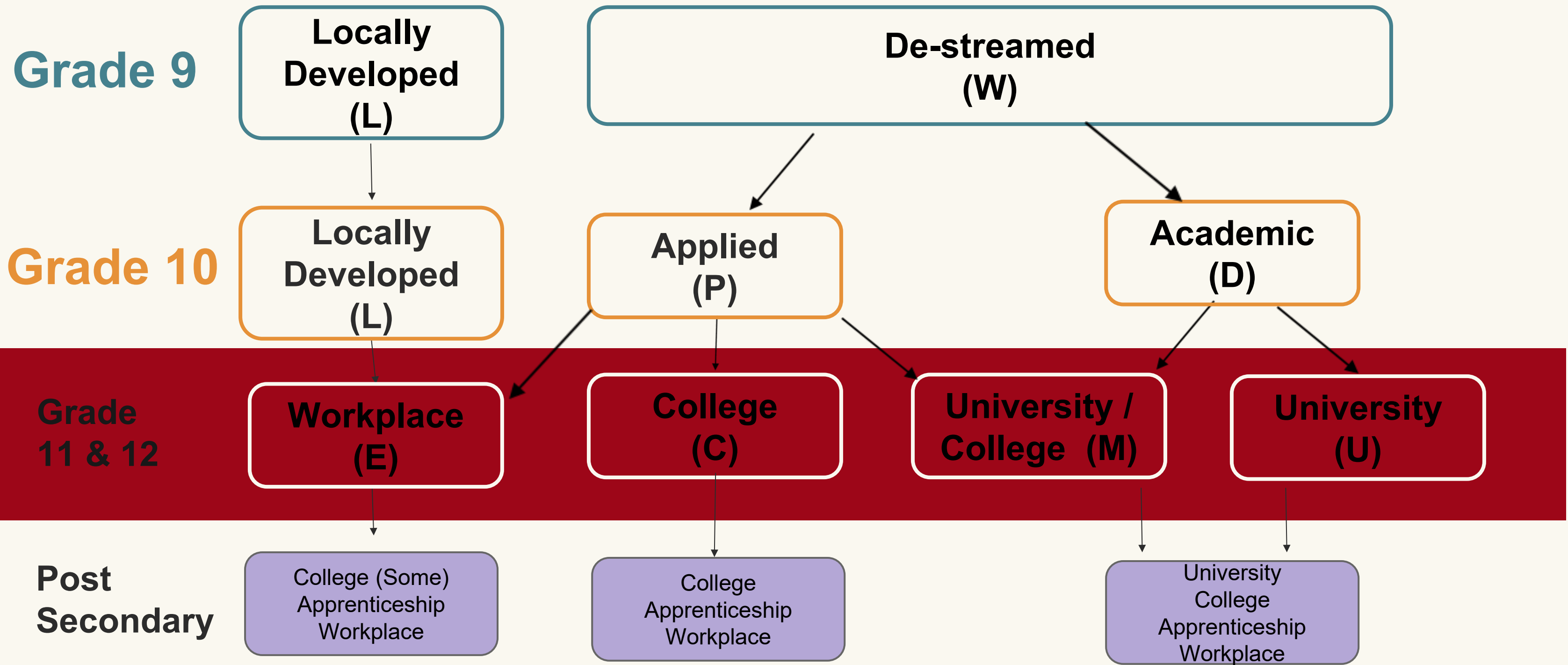

EXPLORE YOUR OP

REQUIREMENTS

Some programs require specific grade 11 and grade 12 courses. They also requires Specific marks in some programs.

RESEARCH

MyBlueprint

SHSM

Career Studies Class

Ontario University Info

Ontario Colleges



Things to consider



-
- ❑ What are you good at?
 - ❑ What do you enjoy?
 - ❑ What might you need later?
 - ❑ What type of learner are you?
 - ❑ Choose wisely now...changes may not be possible.

Next Steps



myBlueprint

Education Planner (7-12)



MyBlueprint

Select MyBlueprint from the MyApps page

Research & Select

Select **HIGH SCHOOL** from left menu

Submit Courses

Due Date:Feb. 28
Tech courses first come first served.

Send Parent Email

Verification

They must approve your selections.

SUPPORT



▣ Parents / Guardians

▣ Teachers

▣ Guidance



Last Name	Guidance	Email
A – Ch ACTIVE & Community	Mr. Kritz	sean.kritz@wcdsb.ca
Ci- Gi Intern'l	Ms. Iley	nadine.iley@wcdsb.ca
Gl – Ma	Ms. McQuinn	cathay.mcquinn@wcdsb.ca
Mc – R ELD	Mr. Meyer	shelley.obright@wcdsb.ca
S – Z	Ms. Jayasundera	kishanie.jayasundera@wcdsb.ca

DEADLINE



Feb.

ANY
QUESTIONS?

